



Hoover Built-in Collection



All Hoover appliances come with a 10 year parts guarantee and 2 year labour. What's more, the comprehensive Hoover After Sales Service Promise covers every eventuality. So, in the unlikely event of a fault occurring there's no need to worry - we take care of everything.



Hoover Customer Service
Tel: 03444 995599



Hoover's activities including all factories and the organisation structure are ISO 9001 accredited. Hoover's policy is one of continuous improvement, therefore we reserve the right to modify or alter specifications and products without prior notice. All products are subject to availability. Information given in this publication relating to installation of appliances is for general guidance only.



Simon Rimm

Hoover Cooking Brand Ambassador

Hoover designs appliances, equipped with the latest technologies, that offer perfect performance with a positive impact on your health and quality of life.



Trust

Hoover is a trusted brand with more than 100 years heritage and offers a wealth of experience in technology and reliability in all of its products.

Performance

Hoover products offer perfect results in terms of performance and effectiveness whilst ensuring total care is provided when looking after laundry, cooking and home needs.

Wellbeing

Hoover is the brand for those who choose the same quality at home that they demand for their life. It is for those that believe in a healthy lifestyle, where wellbeing is important for them and their families.



Free 2 years labour guarantee and 10 year parts* Exclusive to Kitchen Independents

To register for your guarantee for labour and parts follow the four step plan:

- Make a note of all the serial numbers for your new Hoover appliances
- Visit www.hoover2year.com and register your details
- A Registration Confirmation Number will be generated instantly
- Make a note of your Registration Confirmation Number and record overleaf



For your full terms and conditions go to www.hoover2year.com

* 2 Year Guarantee and 10 Year Parts is subject to registration within 30 days from purchase and to the parts being fitted by an official engineer.
*Candy Hoover Group has appointed Domestic & General Insurance PLC to provide product registration services and protection plans to accompany its products. To understand how your data will be used please visit "www.hoover2year.com"



Contents

H-OVENS

6/7 - WI-FI CONNECTIVITY hOn APP

8/9 - COLLECTION 5 OVENS,
COMPACTS & MICROWAVE

10/11 - COLLECTION 3 OVENS
& MICROWAVES

12/13 - H-HOBS

14/15 - H-HOOD

16 - H-DISH

17 - H-WASH

18 - H-FRIDGE & H-FREEZE

19 - SIDE BY SIDE / H-WINE



The Future of Home begins here

Not just a mobile app. hOn brings together all your smart appliances to improve the performance and enhance your daily life. Both at home and outside.

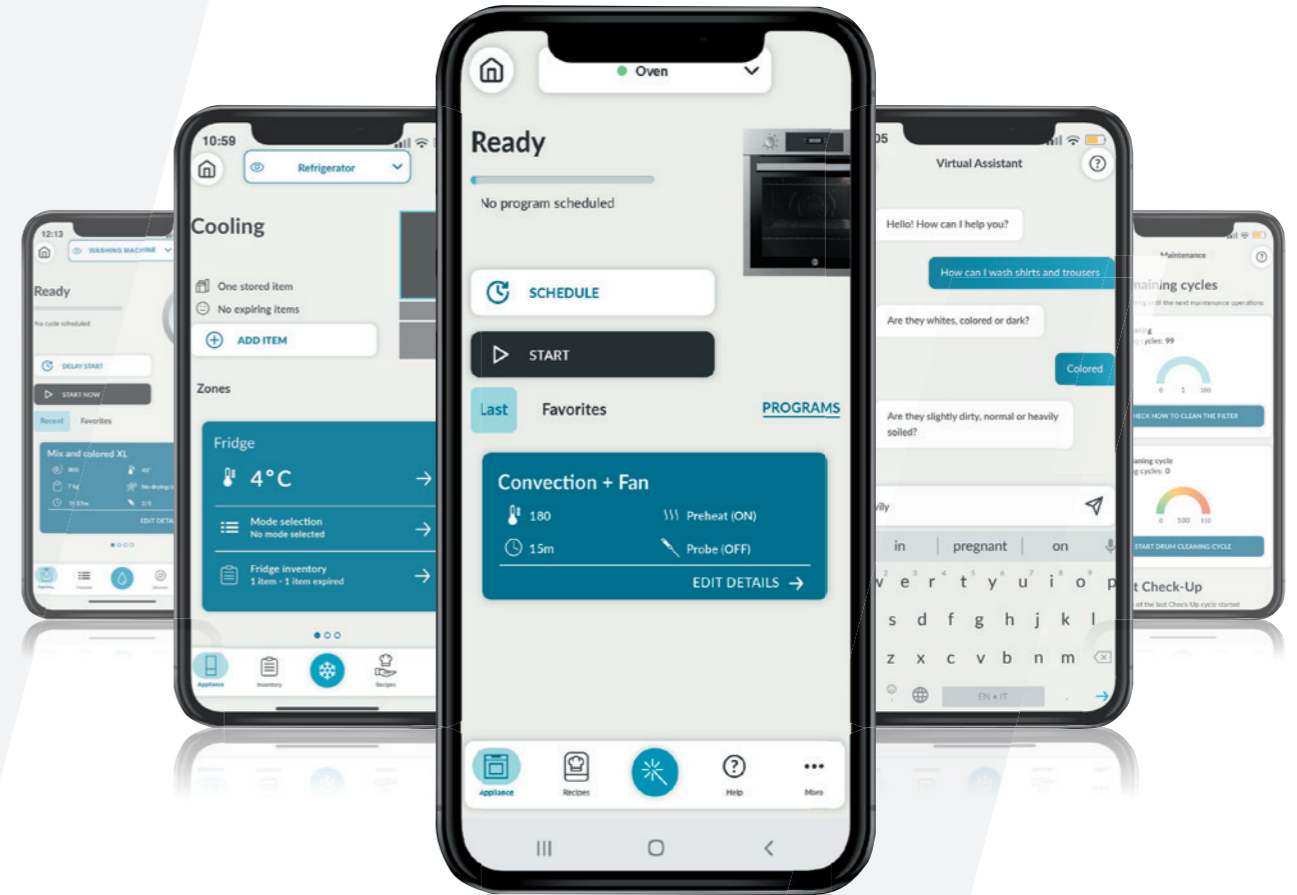

THE HON APP: YOUR SMART HOME COMPANION

SMART HOME HUB

Control all your appliances in one app

REMOTE MONITORING

You will never again forget laundry in the washer or the pizza in the oven...

VOICE CONTROL

hOn is ready to work with Alexa and Google Home to enrich your smart home experience.

ENERGY EFFICIENCY

Statistics and analytics allow a better, more efficient and effective energy management at home



DOWNLOAD APP



TO GET MORE PERFORMANCE



COLLECTION 5

The Collection 5 appliances can be banked vertically or horizontally, finished in brushed Inox and black glass to create a high-end aesthetic in the kitchen. All Ovens are wi-fi connected via the hOn app your smart home companion.



H-OVEN 500 HOC5S0978INPWF 60cm Collection 5 Wi-Fi Multifunction Pyrolytic Oven

- 68 Litre Capacity
- A+ energy efficiency
- 12 Functions (+Wi-Fi)
- Pyrolytic Cleaning
- Touch control interface
- Soft close door
- Multi-Level Cooking
- Triple glazed door
- Click & clean door glass
- Food probe
- Telescopic runners
- Brushed Inox and Black Glass



33703508

H-MICROWAVE 500 HMC34C5S0 45cm Collection 5 Combination Microwave

- 34 Litre Capacity
- 12 Functions
- 6 Power levels
- Touch control interface
- Grill output 1500W
- Microwave output 900W
- 3.2KW connected
- Horizontal alignment
- Brushed Inox and Black Glass



38900719

H-OVEN STEAM 500 HSO45C5S0 45cm Collection 5 Combination Oven with Steam

- 45 Litre Capacity
- Steam Cleaning
- 10 Functions
- Touch control interface
- Soft close door
- 1.2 Litre Water tank
- Steam Injection
- Grill output 1500W
- 3.2KW connected
- Pre set recipes
- Horizontal alignment
- Brushed Inox and Black Glass



33703528

H-OVEN 500 HOC5S047INWIFI 60cm Collection 5 Wi-Fi Multifunction Oven

- 68 Litre Capacity
- A+ energy efficiency
- 11 Functions (+Wi-Fi)
- Hydroeasy Clean Steam Cleaning
- Touch control interface
- Soft close door
- Multi-Level Cooking
- Click & clean door glass
- Food probe
- Telescopic runners
- Brushed Inox and Black Glass



33703441

H-OVEN 500 HOC5S0478INWF 60cm Collection 5 Wi-Fi Multifunction Oven

- 68 Litre Capacity
- A+ energy efficiency
- 11 Functions (+Wi-Fi)
- Hydroeasy Clean Steam Cleaning
- Touch control interface
- Soft close door
- Multi-Level Cooking
- Click & clean door glass
- Telescopic runners



33703597

H-OVEN 500 HOC5S347INWIFI 60cm Collection 5 Wi-Fi Multifunction Oven

- 68 Litre Capacity
- A+ energy efficiency
- 8 Functions (+Wi-Fi)
- Steam Cleaning
- Rotary and touch controls
- Soft close door
- Multifunction (ring & fan)
- Click & clean door glass
- Brushed Inox and Black Glass



33703444

H-MICROWAVE 500 HMG20C5SB-80 38cm Collection Microwave and Grill

- 20 Litre Capacity
- 10 auto programs
- 5 Power levels
- Touch control operation
- LED minute minder
- Grill function 1000W
- Microwave output 800W
- Frameless
- Glass turntable diameter: 255 mm
- Vertical alignment
- Brushed Inox and Black Glass



38900725

H-DRAWER 500 HPWD14C5S 14cm Collection 5 Warming Drawer

- Horizontal alignment
- 20 Litre capacity
- Adjustable temperature 30-70c
- Telescopic drawer
- Dial control
- On/off indicator
- Horizontal alignment
- Dark Inox and Black Glass



36000655



COLLECTION 3

A range that offers long lasting cooking performance. The product suite has a linear design that looks beautiful in any kitchen.



H-OVEN 300 HOC3H3358IN
60cm Collection 3 Multifunction Oven with Catalytic Panels

- 68 Litre capacity
- A+ energy efficiency
- 8 Functions
- LED Full programmer
- Touch & rotary controls
- Catalytic Panels
- Double glazed removable door
- Stainless steel



33703174

H-OVEN 300 HOC3H3058IN
60cm Collection 3 Multifunction Oven

- 65 Litre capacity
- A+ energy efficiency
- 8 Functions
- LED Full programmer
- Touch & rotary controls
- Hydro easy clean
- Double glazed removable door
- Stainless steel



33703177

H-OVEN 300 HOC3H5058IN
60cm Collection 3 Pyrolytic Oven

- 65 Litre capacity
- A energy efficiency
- 9 Functions
- Pyrolytic cleaning
- LED Full programmer
- Touch & rotary controls
- Hydro easy clean
- Triple glazed removable door
- Stainless steel



33703169

H- MICROWAVE 300 HMC440C3H
44 Litre Collection 3 Compact Oven, Microwave and Grill

- 44 Litre Capacity
- 17 Functions
- 13 Automatic programmes
- 5 Power levels
- Touch & rotary controls
- LED display
- Microwave output: 900 W
- Grill output: 1750 W
- Glass turntable diameter: 360mm



38900711

H-MICROWAVE HMG201X-80
20 Litre Microwave with Grill

- 20 Litre capacity
- 4 Functions
- 5 Power levels
- 8 Automatic programmes
- 2 Defrost programmes
- Microwave output: 800 W
- Grill output: 1000 W
- LED minute minder (white display)
- Push button/rotary control operation
- Quick start function
- Glass turntable diameter: 245 mm



38900676

H-OVEN 300 HOC3H3158IN
60cm Collection 3 Multifunction Wi-Fi Oven

- 68 Litre capacity
- A+ energy efficiency
- 8 Functions
- Wi-Fi & Bluetooth connectable via app
- LED Full programmer
- Touch & rotary controls
- Hydro easy clean
- Double glazed removable door
- Stainless steel



33703176



H-OVEN 300 HO9DC3H308IN
90cm Collection 3 Built-in Double Oven

- 68/42 Litres capacity
- A/A energy efficiency
- Upper Cavity: Conventional oven with grill - 8 Functions
- Lower Cavity: Multifunction oven with grill - 4 Functions
- LED Full programmer
- Touch & Rotary controls
- Hydro easy clean
- Double glazed removable door
- Stainless Steel



33703209

H-OVEN 300 HO7DC3B308IN
72cm Collection 3 Built-under Double Oven

- 42/42 Litre capacity
- A/A energy efficiency
- Upper Cavity: Static Top with grill - 4 Functions
- Lower Cavity: Fan Oven with grill - 4 Functions
- LED Full programmer
- Touch & Rotary controls
- Hydro easy clean
- Double glazed removable door
- Stainless Steel



33703186

HMG171X-80
17 Litre Built-in Microwave with Grill

- 17 Litre capacity
- 4 Functions
- 5 Power levels
- 8 Automatic programmes
- 2 Defrost programmes
- Microwave output: 700 W
- Grill output: 1000 W
- LED minute minder (white display)
- Push button/rotary control operation
- Quick start function
- Glass turntable diameter: 245 mm
- Fits into a wall unit



38900677

HOBS

Whatever your cooking preference, there is a Hoover hob that will suit your cooking style and offer the best performance.



“The kitchen is the hub of the home and the epicentre of family life, so it’s important for people to both enjoy cooking and have the right kit to make great food. Hoover is an extremely well known brand with a very impressive cooking portfolio“

Sina Rimm

INDUCTION HOBS

H-HOB 500 HIF585MCTT
77cm Flexi Zone Induction Hob

- 9 Cooking levels
- 3 x 2 Kw (2.6kW Boost)
- 1 x 1.5 Kw (2.0kW Boost)
- 1 x 1.5 Kw (1.8kW Boost)
- Flexibility with 2 linked zones
- Central touch control
- 5 Individual residual heat indicators
- 5 Independent Induction generators
- Independent electronic timer- each zone
- Pan compatibility detection
- Black glass



33802960

H-HOB 500 HTPS64MCTTWIFI
60cm Wi-Fi Induction Hob

- 9 Power Levels
- 2 x 1.50 kW (2kW Boost)
- 2 x 2.00kW (2.6kW Boost)
- Dedicated space for large pots with 21cm rear zone
- WiFi functionality
- Front touch controls
- Independent electronic timer on each zone
- Child safety lock
- Power management
- Black glass



33802971

H-HOB 300 HI642CWIFIT
60cm Wi- Fi Induction Hob

- 60cm Wi- Fi Induction Hob
- 9 Power levels
- 2 x 1.5kW (2.0kW Boost)
- 2 x 2.0kW (2.6kW Boost)
- 21cm rear left zone for large pots
- Central touch control
- WiFi functionality
- Child safety lock
- Independent electronic timer-
- Power management
- Black glass



33803079

H-HOB 300 HI642CTT
60cm Induction Hob

- 2 x 1.5kW (2.0kW Boost)
- 2 x 2.0kW (2.6kW Boost)
- Front touch controls
- 4 Individual residual heat indicators
- 4 Independent Induction generators
- Independent electronic timer on each zone
- Child safety lock
- Power management
- Black glass



33803028

H-HOB 500 HVG6DC5B
60cm Gas on Glass

- 2 x 2.70 kW rapid burner
- 1 x 1.75 kW semi-rapid burners
- 1 x 1.00 kW auxiliary burner
- Flame failure safety device on each burner
- Front rotary control operation
- Gas on glass design
- Automatic ignition
- Heavy duty cast iron stands



33803127

H-HOB 300 HHG75WK3X
75cm Gas Hob

- 1 x 5.00 kW Wok Burner
- 2 x 2.70 kW rapid burner
- 1 x 1.75 kW semi-rapid burners
- 1 x 1.00 kW auxiliary burner
- Flame failure safety device on each burner
- Front rotary control operation
- Automatic ignition
- Wok Burner
- Heavy Duty Cast Iron Pan Stand

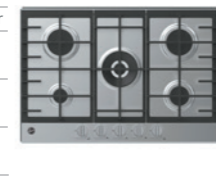

33802790

H-HOB 300 HVG6DK3B
60cm Gas Hob

- 2 x 2.70 kW rapid burner
- 1 x 1.75 kW semi-rapid burners
- 1 x 1.00 kW auxiliary burner
- Flame failure safety device on each burner
- Front rotary control operation
- Gas on glass design
- Automatic ignition
- Heavy duty cast iron pan stands



33802816

CERAMIC HOB

H-HOB 500 HH64DBB3P
60cm Ceramic Hob

- 1 x 1.00/0.70 kW double high-light zone
- 2 x 1.80 kW high-light zones
- 1 x 1.20 kW high-light zone
- Bridge zone
- 4 individual residual heat indicators
- Front touch controls
- Independent electronic timer on each zone
- Child safety lock
- Boiling & melting function
- Black glass

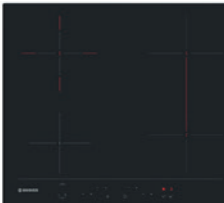

33801926

H-HOB 500 HH64DCT
60cm Ceramic Hob

- 1 x 1.00/1.20 kW double high-light zone
- 1 x 1.80 kW high-light zone
- 2 x 1.20 kW high-light zones
- Front touch control
- 4 Individual residual heat indicators
- Coloured serigraphy
- Power management
- Black glass

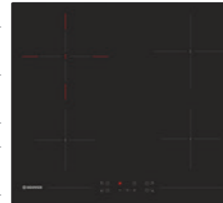

33801928

GAS HOB

H-HOB 500 HVG74WC5B
75cm Gas on Glass Hob

- 1 x 4.5 kW wok burner
- 2 x 2.70 kW rapid burners
- 1 x 1.75 kW semi-rapid burners
- 1 x 1.0 kW auxiliary burner
- Front rotary control operation
- Automatic ignition Wok Burner
- Heavy duty cast iron pan stands
- Flame failure safety device on each burner
- Vertical flame burners
- LPG conversion kit included



33803130

H-HOB 300 HHG6BF4K3X
60cm Gas Hob

- 1 x 4.20 kW Wok Burner
- 1 x 2.70 kW rapid burner
- 1 x 1.75 kW semi-rapid burners
- 1 x 1.00 kW auxiliary burner
- Flame failure safety device on each burner
- Front rotary control operation
- Automatic ignition
- Wok Burner
- Heavy duty cast iron pan stand



33802788

H-HOB 300 HHG6BRK3X
60cm Gas Hob

- 1 x 2.70 kW rapid burner
- 2 x 1.75 kW semi-rapid burners
- 1 x 1.00 kW auxiliary burner
- Flame failure safety device on each burner
- Front rotary control operation
- Automatic ignition
- Heavy duty cast iron pan stands



33802823

H-HOB 300 HHW6LK3X
60cm Gas Hob

- 2 x 2.50 kW rapid burner
- 1 x 1.75 kW semi-rapid burners
- 1 x 1.00 kW auxiliary burner
- Flame failure safety device on each burner
- Side rotary control operation
- Automatic ignition
- Enamelled pan stand

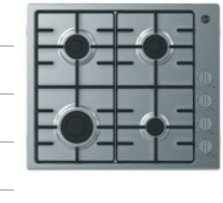

33802858

COOKER HOODS

The Hoover range of hoods cleans the air whilst adding a stylish touch thanks to the contemporary designs finished in stainless steel, black and tinted glass.



* Oven: Collection 5 HOC5S0978INPWF-M
Microwave compact: Collection 5 HMC34C5S0-M
Hood: Collection 5 HDG6DCKB

H-HOOD 700 HDD9800/1B
90 cm Downdraft Extractor

- 4 Extraction speeds
- Touch button control operation
- Extraction capacity: 605 m3/hr
- Noise level: 74 dB
- 1 x 5W LED light
- Washable aluminium grease filters
- Energy efficiency class: B
- Extraction or recirculation
- No return valve
- Timer function
- Filter saturation indicator



36900936

H-HOOD 500 HDC110IN/1
110cm Ceiling Extractor

- 4 Extraction speeds
- LCD Electric switch
- Extraction capacity: 622 m3/hr
- Boost: 758m3/hr
- Noise level: 68 dB
- 4 x 1.5W LED lights
- 4 washable aluminium grease filters
- Energy efficiency class: A
- Outlet 150mm-reducer 120mm included



36901812

H-HOOD 700 HDSVI985B
90 cm Island hood

- 4 Extraction speeds
- Touch button control
- Extraction capacity: 622 m3/hr
- Boost: 758m3/hr
- Noise level: 68 dB
- 4 x 1.1W LED lights
- 3 washable aluminium grease filters
- Energy efficiency class: A
- Outlet 150mm-reducer 120mm included



36900699

H-HOOD 300 HGM900X / HGM600X
90 and 60cm Chimney Glass Hood

- 3 Extraction speeds
- Push button control
- Extraction capacity: 493 m3/hr
- Noise level: 66 dB
- 2 LED lights
- Washable aluminium grease filters
- C energy efficiency
- Stainless steel and glass



36901025 / 36901005

H-HOOD 300 HGM610NN
60cm Chimney Glass Hood

- 3 Extraction speeds
- Push button control
- Extraction capacity: 493 m3/hr
- Noise level: 66 dB
- 1 x 2W LED light
- Washable aluminium grease filter
- Energy efficiency class: C
- Outlet 150mm-reducer 120mm included
- Black and tinted glass



36901009

H-HOOD 300 HCE160X
60cm Chimney Hood

- 3 Extraction speeds
- Push button control
- Extraction capacity: 525 m3/hr
- Noise level: 67 dB
- LED light
- 2 x washable aluminium grease filters
- Energy efficiency class: C
- Stainless steel



Available in Black: 60cm HCE160N
36901001 / 36901004

H-HOOD 500 HDSV985B / HDSV685B
90cm and 60cm T-shaped Hood

- 4 Extraction speeds
- Touch control
- Extraction capacity: 498 m3/hr
- Noise level: 62 dB
- 2 LED lights
- Washable aluminium grease filters
- A energy efficiency
- Stainless steel and glass



36900764 / 36900762

H-HOOD 500 HDG9DCK3B / HDG6DCK3B
90cm and 60cm Angled Glass Hood

- 4 Extraction speeds
- Touch button control
- Extraction capacity: 618 m3/hr Boost: 710m3/h
- Noise level: 65 dB
- 2 x 1.5W rectangle LED light
- Washable aluminium grease filters
- Energy efficiency class: A
- Outlet 150mm-reducer 120mm included



36901621 / 36901620

H-HOOD 300 HTS9CBK3X / HTS6CBK3X
90cm and 60cm T-Shaped Hood

- 4 Extraction speeds
- Touch button control
- Extraction capacity: 610 m3/hr Boost: 735m3/h
- Noise level: 67 dB
- 2 x 1.5 W rectangle LED lights
- Washable aluminium grease filters
- Energy efficiency class: A
- Outlet 150mm-reducer 120mm included
- FCR17 Carbon Filter x2 (Included)
- Black Glass Front Panel



36901625 / 36901626

H-HOOD 300 HBG750X
75cm Canopy Hood

- 3 Extraction speeds
- Slide switch control
- Extraction capacity: 615 m3/hr
- Noise level: 69 dB
- 2 x 2W round LED lights
- Washable aluminium grease filter
- Energy efficiency class: B
- Outlet 150mm-reducer 120mm included



36901011

H-HOOD 100 HBG152N
52cm Canopy Hood

- 3 Extraction speeds
- Slide switch control
- Extraction capacity: 197 m3/hr
- Noise level: 68 dB
- 2 x 2W round LED lights
- Washable aluminium grease filter
- Energy efficiency class: C
- Outlet 150mm-reducer 120mm included



36901014

H-HOOD 100 HHT6300/2X
60cm Telescopic Hood

- 2 Extraction speeds
- Switch control
- Extraction capacity: 329 m3/hr
- Noise level: 64 dB
- 1 x LED lights
- 2 x washable aluminium grease filters
- Energy efficiency class: B



36901053



DISHWASHERS

From a slimline model for a smaller kitchen to standard size models, every model in the Hoover collection boasts impressive features with Wi-Fi models being managed remotely.

INTEGRATED DISHWASHERS

H-DISH 700 HDIN 4S613PS-80/E 60cm Integrated Wi-Fi Dishwasher

- 16 Place settings
- 12 Programmes
- 6 Temperatures
- C energy efficiency
- Wi-Fi & Bluetooth
- Total Care performance
- Powerwash function
- Aquastop safety system
- Automatic door opening
- Add dish feature
- Third Drawer
- Silver control panel



32901465

H-DISH 500 HDIN 4D620PB-80 60cm Integrated Wi-Fi Dishwasher

- 16 Place settings
- 9 Programmes
- 6 Temperatures
- C energy efficiency
- Wi-Fi & Bluetooth
- Aquaprotect safety system
- Automatic door opening
- Add dish feature
- Self cleaning triple filter system
- Delay start
- Black control panel



32901447

H-DISH 300 HDI 1L038SA-80/T 60cm Integrated Dishwasher

- 13 Place settings
- 5 Programmes
- 4 Temperatures
- F energy efficiency
- Height adjustable upper basket
- Self cleaning triple filter system
- Delay start
- Silver control panel



32901384

H-DISH 500 HDIH 2T1047 45cm Integrated Slimline Dishwasher

- 10 place settings
- 8 programmes
- E energy efficiency
- Height adjustable basket
- Delay start (24 hours)
- Half load function
- Salt and rinse aid indicator
- Silver with black control panel



32901524

LAUNDRY

The laundry models provide washing and drying solutions for your needs and provides the best care for your clothing. The connected models allow remote access and also suggest the best wash programmes to use based on what you want to wash.



H-WASH 300 HBWOS 69TAMCBE-80 9KG 9KG Integrated Wi-Fi Washing Machine

- 9kg load capacity
- 15 Wash Programmes (upto 20 additional cycles via the app)
- 1600 rpm spin speed
- A Energy efficiency
- Total Care programmes
- Wi-Fi connectable
- LED Display with countdown indicator
- Steam function
- KG detector
- Rapid Wash 14, 30, 44 mins
- Delay start up to 24 hours
- Black and Chrome



31800898

H-WASH 300 HBWS 59D1ACE-80 9KG Integrated Washing Machine

- 9kg load capacity
- 16 Wash Programs
- 1500 rpm spin speed
- C Energy Rating
- Delay Start
- Steam function
- Rapid Wash Cycles 14,30,44
- LED Display with countdown indicator
- KG Detector



31800892

H-WASH 300 HBWS 58D1ACE-80 8KG Integrated Washing Machine

- 8kg load capacity
- 16 Wash Programs
- 1500 rpm spin speed
- C Energy Rating
- Delay Start
- Active Steam function
- Rapid Wash Cycles 14,30,44
- LED Display with countdown indicator
- KG detector



31800889

H-WASH & DRY 300 HBDS 585D1ACE-80 8KG Integrated Washer Dryer

- 8kg/5kg load capacity
- 15 wash programmes including total care programmes
- 1500 rpm spin speed
- C/E energy efficiency
- 3 dry programmes
- Delay start upto 24 hours
- KG detector
- LED Display with countdown indicator
- Steam function



31800903

H-DRY 300 BATD H7A1TCE-80 7kg Integrated Wi-Fi Heat Pump Tumble Dryer

- 7kg load capacity
- 15 Drying programmes
- A+ energy efficiency
- Total Care technology -Looks after all your clothes and perfect for wools, delicates and other special cycles.
- AquaVision in door water container
- Wi-Fi & Bluetooth connectivity
- Choice of 3 dryness levels
- KG detector
- Delay start upto 24 hours



31900536

H-DRY 300 BATDH7A1TCEB-80 7kg Integrated Wi-Fi Heat Pump Tumble Dryer

- 7kg load capacity
- 15 Drying programmes
- A+ energy efficiency
- Total Care technology -Looks after all your clothes and perfect for wools, delicates and other special cycles.
- AquaVision in door water container
- Wi-Fi & Bluetooth connectivity
- Choice of 3 dryness levels
- KG detector
- Delay start upto 24 hours



31900531

REFRIGERATION

The Hoover fridge collection offers a wide range of choice based on size, performance and technology.



INTEGRATED REFRIGERATION

H-FRIDGE 300 HOB50N518FVK
228 Litre Integrated 50:50 Frost Free Fridge Freezer

- Net capacity: 150/78 litres
- F energy efficiency
- Frost Free Cooling Technology
- Adjustable thermostat
- LED sky lighting
- Chrome wine rack
- 4 Glass shelves
- 4 Transparent freezer drawers
- Reversible door
- Slider fittings
- White
- Smart Content available with the hOn app

34901471

H-FRIDGE 300 HOB50S518FK
233 Litre Integrated 50:50 Fridge Freezer

- Net capacity: 150/83 litres
- F energy efficiency
- Manual Freezer defrost required
- Adjustable thermostat
- LED sky lighting
- 4 Glass shelves
- 4 Transparent freezer drawers
- Reversible door
- Slider fittings
- White
- Smart Content available with the hOn app

34901465

H-FRIDGE 500 HOBT5518EWK
248 Litre Integrated 70:30 Total No Frost Fridge Freezer

- Net capacity: 186/62 litres
- E energy efficiency
- Total No Frost Cooling Technology
- Electronic control system
- Wi-Fi connectivity
- Door Alarm
- 4 Glass shelves
- 3 Transparent freezer drawers
- Reversible door
- Slider fittings
- White

34901417

H-FREEZE 500 HBOU 172UK /N
204 Litre Integrated Freezer

- Net capacity: 204 litres
- F energy efficiency
- Manual defrost
- Super freeze option
- 9 Transparent freezer drawers
- White

37900563

H-FRIDGE 500 HBOL 172UK /N
316 Litre Integrated Larder Fridge

- Net capacity: 316 litres
- F energy efficiency
- Automatic fridge defrost
- LED sky lighting
- LED sky fan
- 6 Glass shelves
- Wine rack
- White

34901228

H-FRIDGE 700 HHSBSO 6174XWDK
518 Litre Side by Side Freestanding Fridge Freezer

- Net Capacity 341L/177L
- E energy efficiency
- Total No Frost
- Water Dispenser
- Digital Display
- Smart Mode
- LED lighting
- 4 Fridge shelves
- 2 Freezer drawers
- 4 Freezer shelves
- Stainless Steel
- H1770 x W900 x D640 mm

34004186

H-FRIDGE 700 HHSBSO 6174XK
521 Litre Side by Side Freestanding Fridge Freezer

- Net Capacity 344L/177L
- E energy efficiency
- Total No Frost
- Digital Display
- Smart Mode
- LED lighting
- 4 Fridge shelves
- 2 Freezer drawers
- 4 Freezer shelves
- Stainless Steel
- H1770 X W900 X D660 mm

34004186

WINE STORAGE

H-FRIDGE 500 HOBT3518FWK
248 Litre Integrated 70:30 Total No Frost Fridge Freezer

- Net capacity: 186/62 litres
- F energy efficiency
- Total No Frost Cooling Technology
- Electronic control system
- Wi-Fi connectivity
- Door Alarm
- 4 Glass shelves
- 3 Transparent freezer drawers
- Reversible door
- Slider fittings
- White

34901415

H-FRIDGE 300 HOBL3518EVWK
263 Litre Integrated 70:30 Low Frost Fridge Freezer

- Net capacity: 190/73 litres
- E energy efficiency
- Low Frost Cooling Technology
- Wi-Fi connectivity
- Door Alarm
- Wine rack
- 4 Glass shelves
- 3 Transparent freezer drawers
- Reversible door
- Slider fittings
- White

34901413

H-FRIDGE 300 HOBL3518FK
264 Litre Integrated 70:30 Low Frost Fridge Freezer

- Net capacity: 191/73 litres
- F energy efficiency
- Low Frost Cooling Technology
- Door Alarm
- 4 Glass shelves
- 3 Transparent freezer drawers
- Reversible door
- Slider fittings
- White

34901411

H-WINE 700 HWCB 60D UK/N
38 Bottle Entertainment Centre

- 38 x 0.75L Bordeaux wine bottles
- LED Display
- G energy efficiency
- 12 Wooden shelves
- Anti-UV tinted glass door
- Fan assisted operation
- Adjustable temperature
Left compartment: 5-22°C
Right compartment: 2-22°C
- Black with stainless steel frame
- Smart contents available with the hOn app in collaboration with Vivino

34901281

H-WINE 300 HWCB 60 UK/N
46 Bottle Wine Cabinet

- 46 x 0.75L Bordeaux wine bottles
- LED Display
- G energy efficiency
- 6 Wooden shelves
- Anti-UV tinted glass door
- Fan assisted operation
- Adjustable temperature
Upper zone: 5-12°C
Lower zone: 12-22°C
- Black with stainless steel frame
- Smart contents available with the hOn app in collaboration with Vivino

34901286

H-FRIDGE 300 HBRUP 170 NKE/1
135 Litre Built-under Fridge

- Net capacity: 135 litres
- F energy efficiency
- Automatic fridge defrost
- Adjustable thermostat
- 3 Glass shelves
- 2 Door shelves
- Reversible door
- Fixed hinge door fittings
- White

34901375

H-FRIDGE 300 HBRUP 174 NKE/NE
111 Litre Built-under Fridge with ice box

- Net capacity: 95/16 litres
- F energy efficiency
- Automatic fridge defrost
- Icebox - manual defrost
- 2 Glass shelves
- 2 Door shelves
- Reversible door
- Fixed hinge door fittings
- White

34901376

H-FREEZE 300 HBFUP 130 NK/E
95 Litre Built-under Freezer

- Net capacity: 95 litres
- F energy efficiency
- Manual defrost
- Adjustable thermostat
- 3 Transparent freezer drawers
- Ice cube tray
- Reversible door
- Fixed hinge door fittings
- White

37900570

H-WINE 500 HWCB 30 UK/N
20 Bottle Wine Cabinet

- 20 x 0.75L Bordeaux wine bottles
- LED Display
- F energy efficiency
- 6 Wooden shelves
- Anti-UV tinted glass door
- Fan assisted operation
- Adjustable temperature 5-22°C
- Black with stainless steel frame
- Smart contents available with the hOn app in collaboration with Vivino

34901279

H-WINE 300 HWCB 15 UK/1
7 Bottle Wine Cabinet

- 7 x 0.75L Bordeaux wine bottles
- LED Display
- G energy efficiency
- 6 Wooden shelves
- Anti-UV tinted glass door
- Fan assisted operation
- Adjustable temperature 5-22°C
- Black with stainless steel frame
- Smart contents available with the hOn app in collaboration with Vivino

34901203

H-OVEN 500 HOC5S0978INPWF
60cm Collection 5 Multifunction Pyrolytic Oven

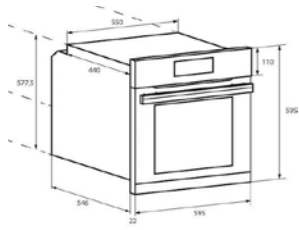

H-OVEN 500 HOC5S047INWIFI
60cm Collection 5 Multifunction Oven

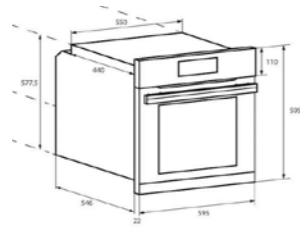

H-OVEN 500 HOC5S0478INWF
60cm Collection 5 Multifunction Oven

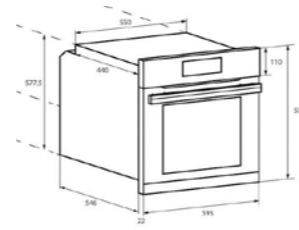

H-OVEN 300 HOC3H5058IN
60cm Collection 3 Pyrolytic Oven

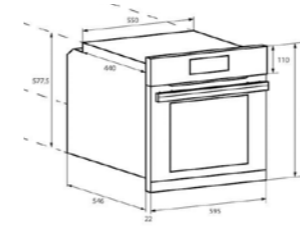

H-OVEN 300 HOC3H3158IN
60cm Collection 3 Multifunction Wi-Fi Oven

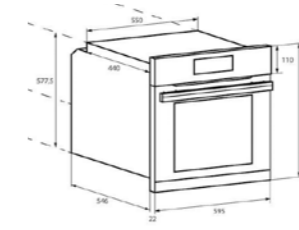

H-OVEN 300 HOC3H3358IN
60cm Collection 3 Multifunction Oven with Catalytic Panels

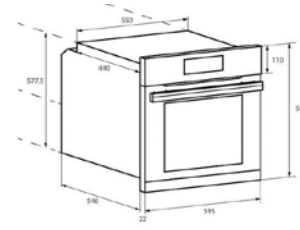

H-OVEN 500 HOC5S347INWIFI
60cm Collection Multifunction Oven

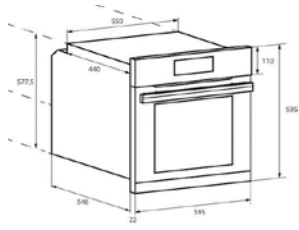

H-MICROWAVE 500 HMC34C5S0
45cm Collection 5 Combination Microwave

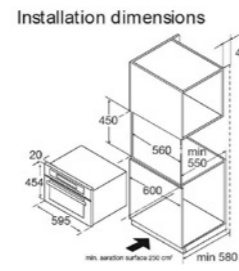

H-OVEN STEAM 500 HSO45C5S0
45cm Collection 5 Combination Oven with Steam

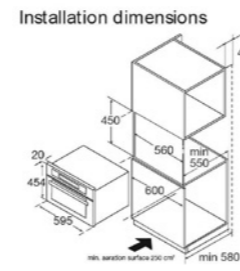

H-OVEN 300 HOC3H3058IN
60cm Collection 3 Multifunction Oven

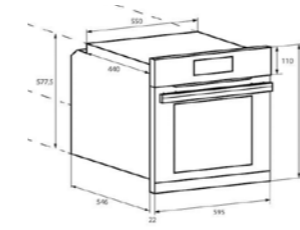

H-OVEN 300 HO9DC3H308IN
90cm Collection 3 Built-in Double Oven

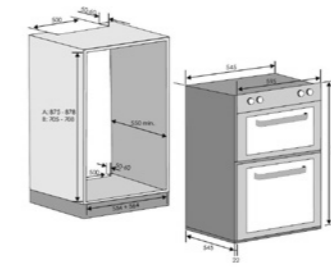

H-OVEN 300 HO7DC3B308IN
72cm Collection 3 Built-under Double Oven

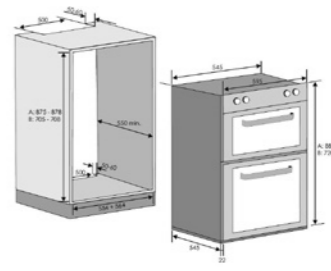

H-MICROWAVE 500 HMG20C5SB-80
38cm Collection Microwave and Grill

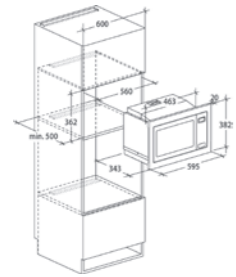

H-DRAWER 500 HPWD14C5S
14cm Collection 5 Warming Drawer

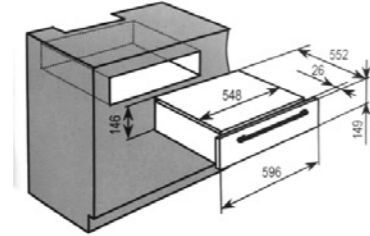

H- MICROWAVE 300 HMC440C3H
44 Litre Collection 3 Compact Oven, Microwave and Grill



H-MICROWAVE HMG201X-80
20 Litre Collection 3 Microwave with Grill

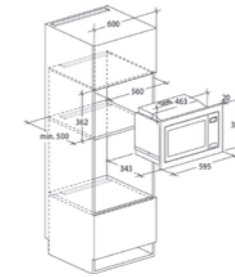

HMG171X-80
17 Litre Collection 3 Built-in Microwave with Grill fits into a wall unit

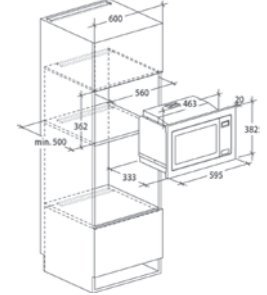

H-HOB 700 HIFS85MCTT
80cm Flexi Zone Induction Hob

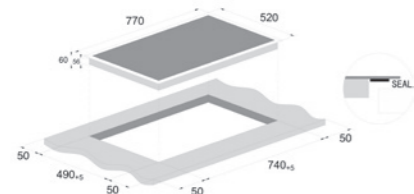

H-HOB 700 HTPS64MCTTWIFI
60cm Wi-Fi Induction Hob

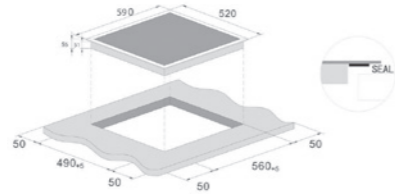

H-HOB 300 HI642CTT
60cm Induction Hob

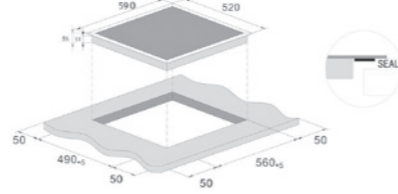

H-HOB 300 HI642CWIFIT
60cm Wi-Fi Induction Hob

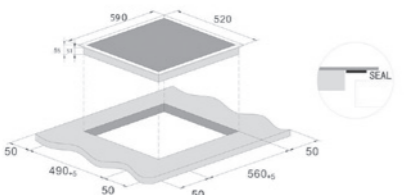

H-HOB 500 HH64DBB3P
60cm Ceramic Hob

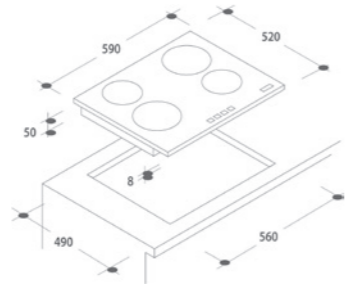

H-HOB 500 HH64DCT
60cm Ceramic Hob

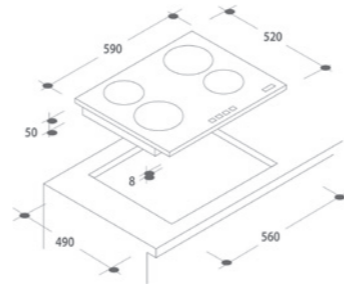

H-HOB 700 HVG7W4SB
75cm Gas on Glass Hob

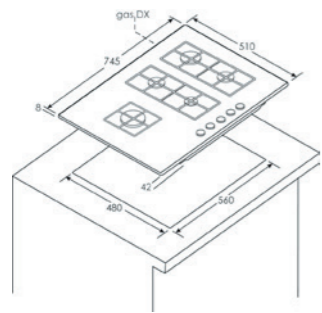

H-HOB 500 HVG6DC5B
60cm Gas on Glass

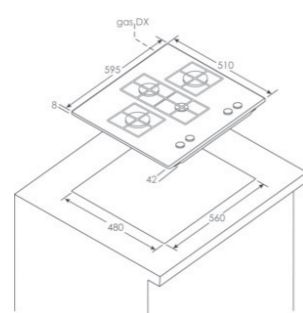

H-HOB 300 HHG75WK3X
75cm Gas Hob

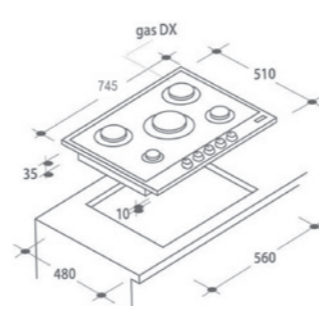

H-HOB 300 HVG6DK3B
60cm Gas Hob

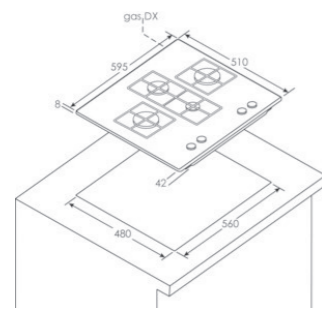

H-HOB 300 HHG6BF4K3X
60cm Gas Hob

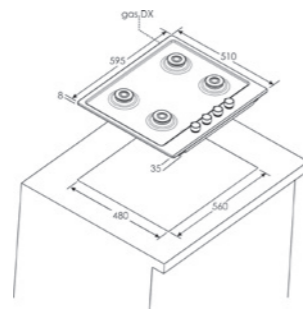

H-HOB 300 HHG6BRK3X
60cm Gas Hob

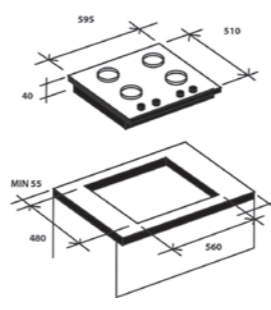

H-HOB 300 HHW6LK3X
60cm Gas Hob

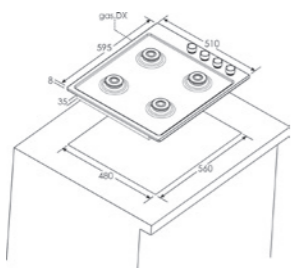

H-HOOD 700 HDD9800/1B
90 cm Downdraft Extractor

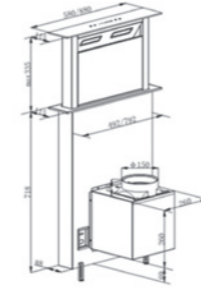

H-HOOD 700 HDC 110/IN
110cm Ceiling Extractor

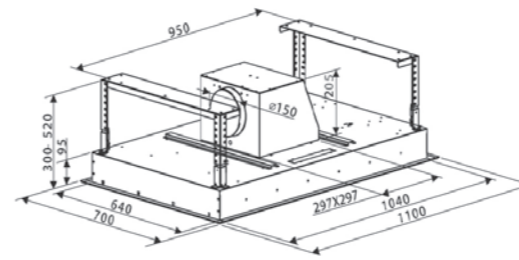

H-HOOD 700 HDSVI985B
90 cm Island hood

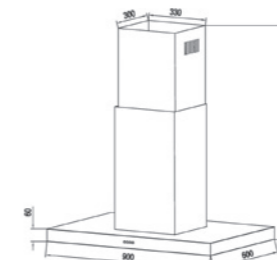

H-HOOD 500 HDSV985B / HDSV685B
90cm and 60cm T-shaped Hood

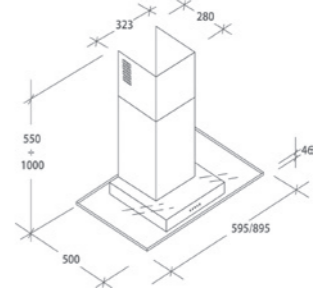

H-HOOD 500 HDG9DCK3B / HDG6DCK3B
90cm and 60cm Angled Glass Hood

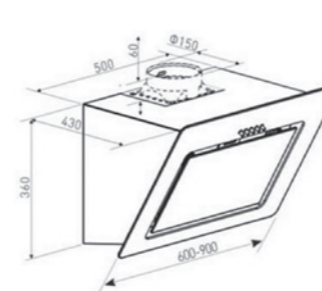

H-HOOD 300 HTS9CBK3X / HTS6CBK3X
90cm and 60cm T-Shaped Hood

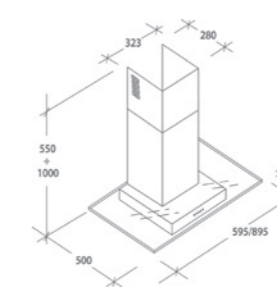

H-HOOD 300 HGM900X
90cm Chimney Glass Hood

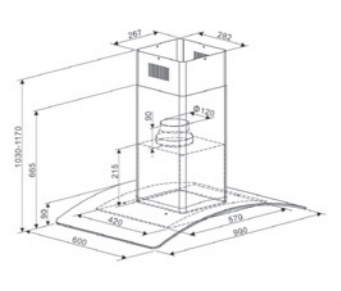

H-HOOD 300 HGM610NN / HGM600X
60cm Chimney Glass Hood

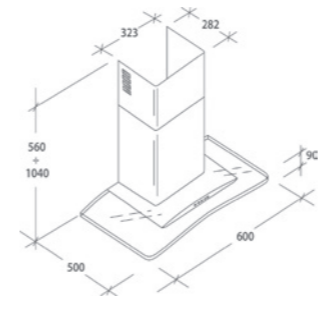

H-HOOD 300 HCE160X / HCE160N
60cm Chimney Hood

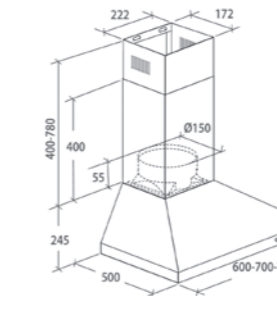

H-HOOD 300 HBG750X
75cm Canopy Hood

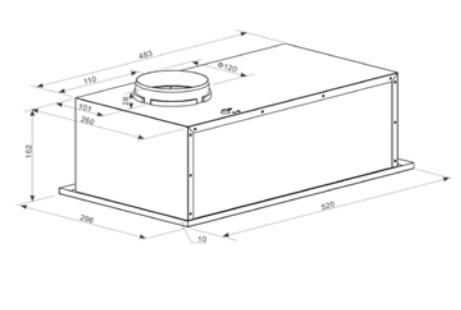

H-HOOD 100 HBG152N
52cm Canopy Hood

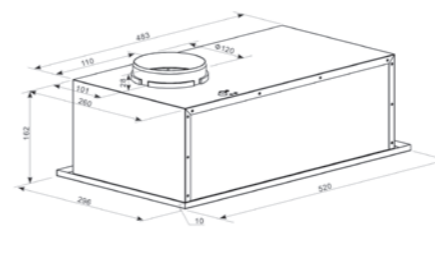

H-HOOD 100 HHT6300/2X
60cm Telescopic Hood

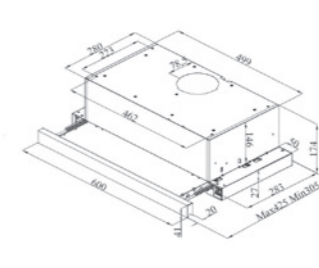

H-DISH 700 HDIN 4S613PS-80/E
60cm Integrated Wi-Fi Dishwasher

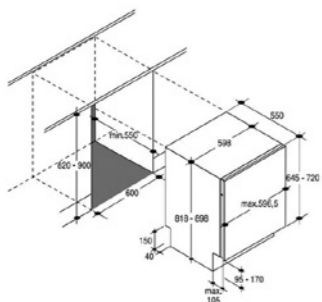

H-DISH 500 HDIN 4D620PB-80
60cm Integrated Wi-Fi Dishwasher

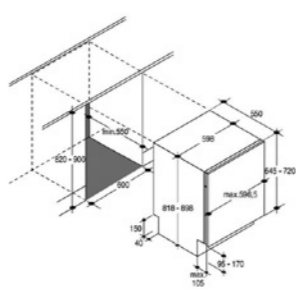

H-DISH 300 HDI 1LO38SA-80/T
60cm Integrated Dishwasher

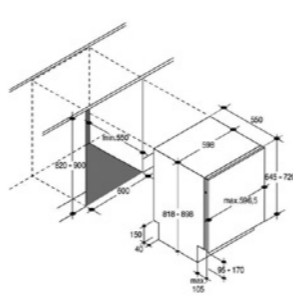

H-FRIDGE 300 HOBL3518FK
264 Litre Integrated 70:30 Low Frost Fridge Freezer

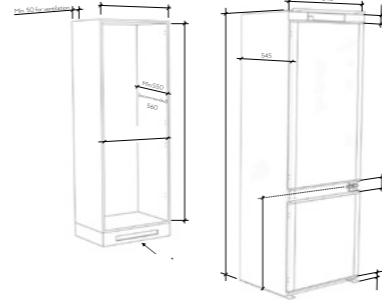

H-FRIDGE 300 HBRUP 170 NKE/1
135 Litre Built-under Fridge

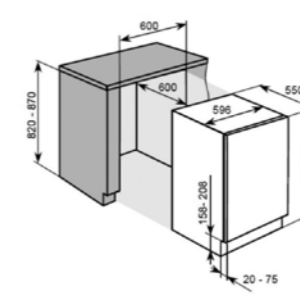

H-FRIDGE 300 HBRUP 174 NK/NE
111 Litre Built-under Fridge with ice box

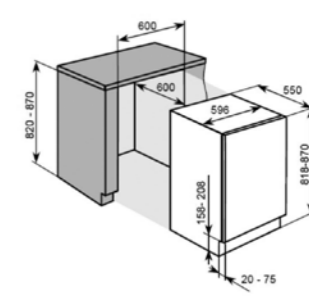

H-DISH 500 HDIH 2T1047
45cm Integrated Slimline Dishwasher

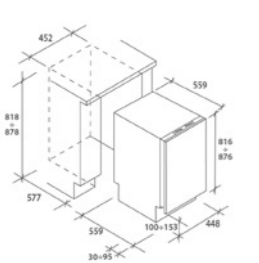

H-WASH 300 HBWOS 69TAMCBE-80 9KG
9KG Integrated Wi-Fi Washing Machine

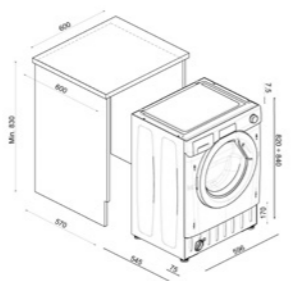

H-WASH 300 HBWS 59D1ACE-80
9KG Integrated Washing Machine

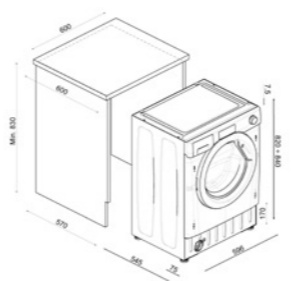

H-FREEZE 300 HBFUP 130 NK/E
95 Litre Built-under Freezer

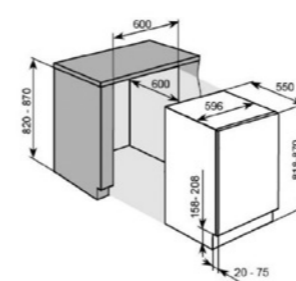

H-FREEZE 500 HBOU 172UK /N
217 Litre Integrated Freezer

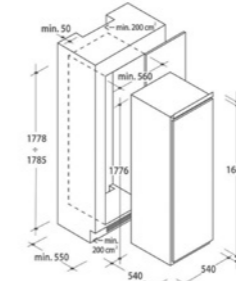

H-FRIDGE 500 HBOL 172UK /N
316 Litre Integrated Larder Fridge

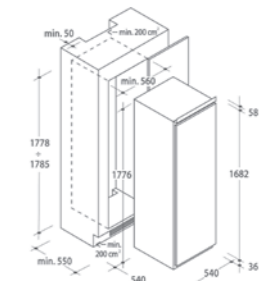

H-WASH 300 HBWS 58D1ACE-80
8KG Integrated Washing Machine

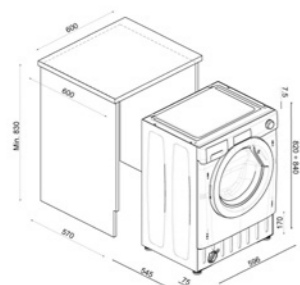

H-WASH & DRY 300 HBDS 585D1ACE-80
8KG Integrated Washer Dryer

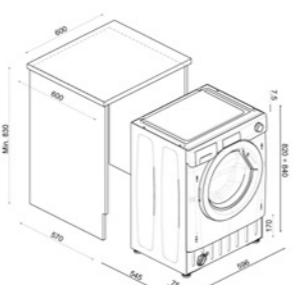

H-DRY 300 BATDH7A1TCEB-80
7KG Integrated Wi-Fi Heat Pump Tumble Dryer

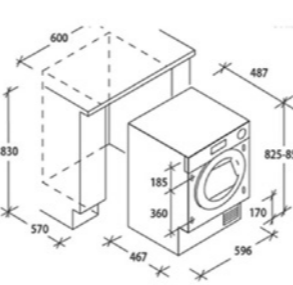

H-WINE 700 HWCB 60D UK/N
38 Bottle Entertainment Centre

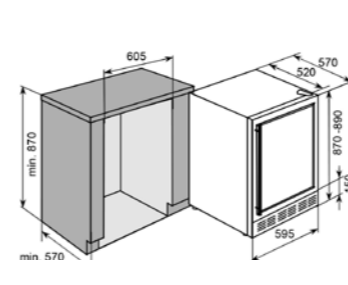

H-WINE 300 HWCB 60 UK/N
46 Bottle Wine Cabinet

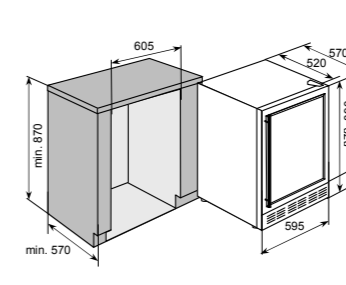

H-WINE 500 HWCB 30 UK/N
20 Bottle Wine Cabinet

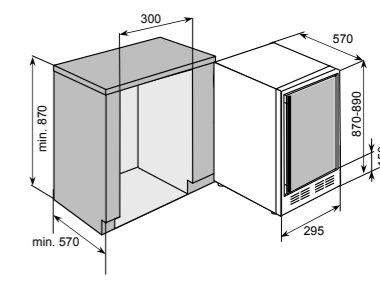

H-DRY 300 BATD H7A1TCE-80
7KG Integrated Wi-Fi Heat Pump Tumble Dryer

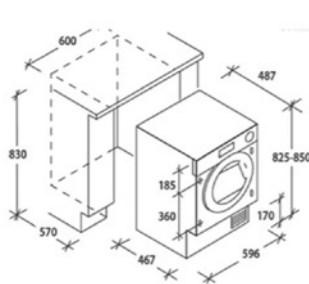

H-FRIDGE 300 HOB50N518FVK
228 Litre Integrated 50:50 Frost Free Fridge Freezer

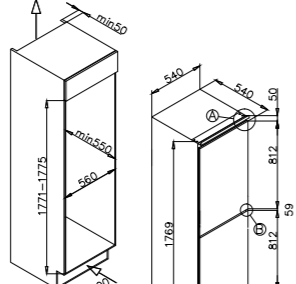

H-FRIDGE 300 HOB50S518FK
233 Litre integrated 50:50 Fridge Freezer

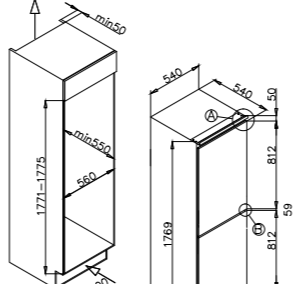

H-WINE 300 HWCB 15 UK/1
7 Bottle Wine Cabinet

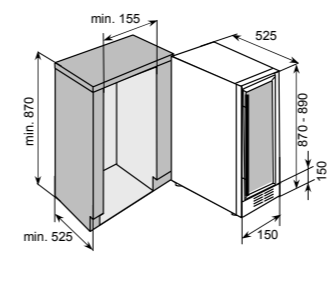

H-FRIDGE 300 HOBL3518EVWK
263 Litre Integrated 70:30 Low Frost Fridge Freezer

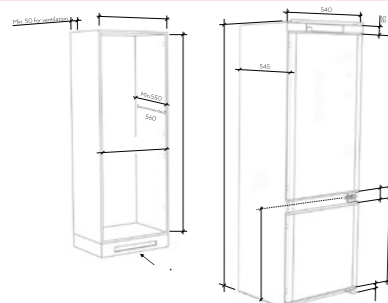

H-FRIDGE 500 HOBT5518EWK
248 Litre Integrated 70:30 Total No Frost Fridge Freezer

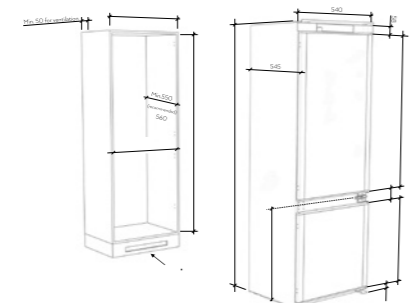

H-FRIDGE 500 HOBT3518FWK
248 Litre Integrated 70:30 Total No Frost Fridge Freezer

